



SOLARCON
ANTENNA RESEARCH

Catalog 2005

MAX2000

The Ultimate 10-11 Meter Base Station Antenna

5/8 Wave Heavy Duty Fiberglass Omnidirectional Base Station Antenna

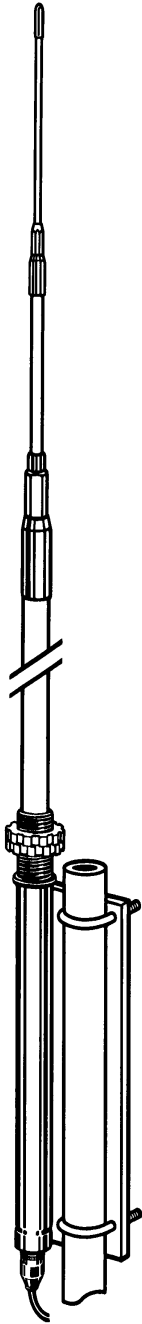

- Covers 26 MHz to 33.5 MHz using patented tuning rings and trimming the top section; approximately twice the 2:1 SWR bandwidth as the A-99/MAX-99 (3MHz with SWR<2:1)
- Entire antenna radiates producing a gain 1 to 2 db higher than the best of the competitors 5/8 wavelength antennas
- Antenna tested to 5000 watts without failure
- Mounting system provides easy one piece installation
- Long ferrules make for a mechanically strong antenna
- Comes in three 8 foot sections which are UPS shippable at premium rates
- Meets or exceeds CPSC shock hazard standards
- Add the MAX GPK ground plane kit for even better performance

| MODEL NO. | LENGTH | CASE QTY. |
|-----------|-----------------|-----------|
| MAX2000 | 24' | 6 |
| MAXGPK | Each Radial 48" | 8 |
| MAX2000CK | 28' 6" | 6 |

GROUNDPLANE KIT

- Lowers angle of radiation for greater range
- Kit includes 1 mounting bracket and 4 fiberglass radials
- New mounting bracket makes it possible to add to already installed A99 or MAX antennas
- Can be added to other base station antennas that use 1 3/4" centered U-bolts or bolt spacing
- Can ship UPS at standard rates

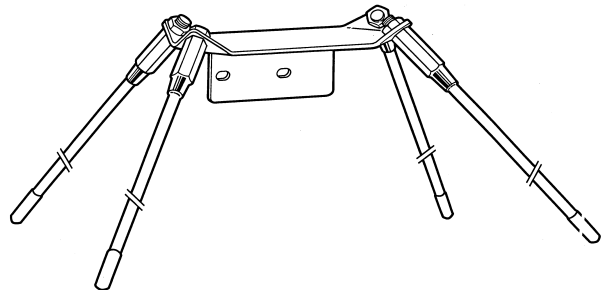

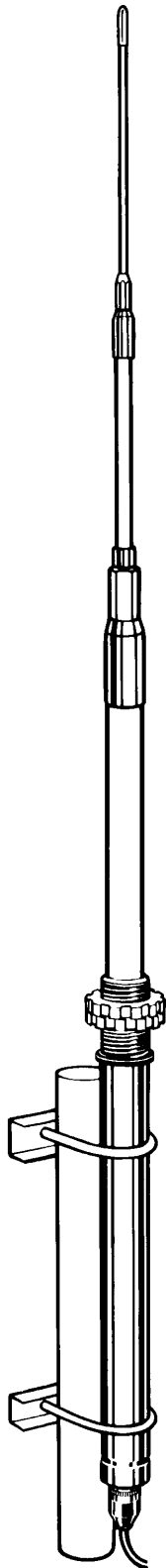

A99

The A-99 features the Solarcon **Twin Ring Adjust-A-Match** tuning making it possible to tune the input to the antenna and obtain the optimum S.W.R. over a range of frequencies. Raising the rings raises the frequency and lowering the rings lowers the frequency.

U.S. Patent #4,360,814. Canadian Patent #1,145,456. England Patent #2,046,529. Other patents pending.

Operates 10 thru 17 Meters With Tuner

1/2 Wave Fiberglass Omnidirectional Base Station Antenna

- Covers far above and below the traditional C.B. channels for export, commercial and 10 meter ham band use, input 2000 watts P.E.P.
 - The A99 is a half wave over a quarter wave variable mutual transductance tuned antenna
 - Comes in three sections, easy to assemble
 - Entire antenna radiates 9.9 DBI Gain
 - Will ship U.P.S. at regular rate. NOT OVERSIZE
 - Each antenna individually tested
 - Meets U.S. government CPSC shock hazard standards. Protects up to 14,500 volts
-
- Lowers angle of radiation for greater range
 - Kit includes 1 collar and 4 fiberglass radials
 - U.P.S. shippable at standard rates

THE SKIP KIT

GPK-1

Groundplane kit for A-99

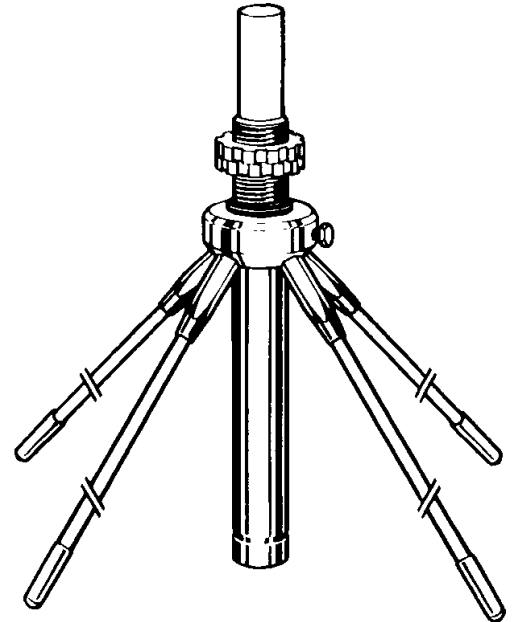

| MODEL NO. | LENGTH | CONNECTOR | CASE QTY. |
|---------------|-----------------|-------------------------|-----------|
| A-99 | 17' 4" | SO-239 | 9 |
| GPK-1 | Each Radial 70" | Fits Bottom Sleeve A-99 | 9 |
| A-99CK | 27' 6" | A-99 and GPK-1 | 6 |

VMT SERIES

Individual VMT Antennas

- Solarcon's patented Adjust-A-Match tuning
- No cutting - just twist the rings for lowest SWR and optimum performance
- Stainless steel whip
- Chrome-plated brass 3/8" x 24 thread ferrule

| VMT Antennas | | |
|--------------|--------|-----------|
| MODEL NO. | LENGTH | CASE QTY. |
| A-108 | 8" | 24 |
| A-110 | 24" | 6 |
| A-110S | 24" | 6 |
| A-111 | 36" | 6 |
| A-112 | 43" | 6 |

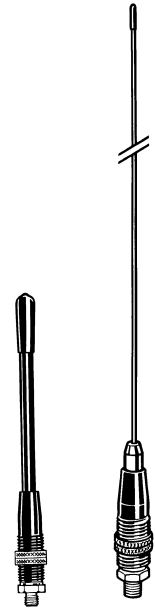

Plastic Magnet Mount Kit

- Solarcon's patented VMT antenna
- Pre-wired 3' encapsulated plastic magnet mount with 12' of RG58/AU cable and soldered PL-259 connector
- **Completely waterproof design**, with all internal connections soldered
- 6 pole magnet for high holding power
- Each unit factory tested

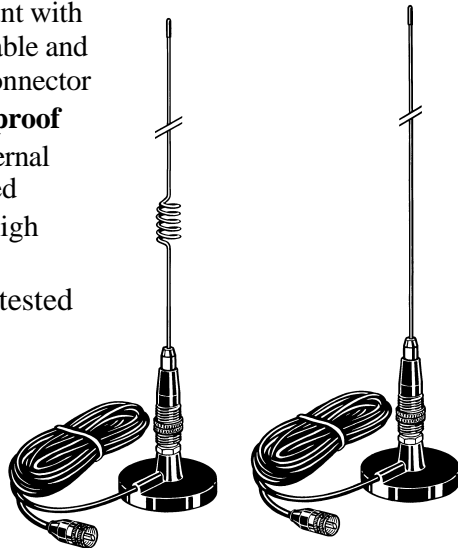

| VMT Magnet Mount | | |
|------------------|---------------|-----------|
| MODEL NO. | ANTENNA STYLE | CASE QTY. |
| A-108PM | A-108 | 12 |
| A-110PM | A-110 | 8 |
| A-110PMS | A-110S | 8 |
| A-111PM | A-111 | 8 |
| A-112PM | A-112 | 8 |

TRX-1011

- Base loaded 1/4 wave
- Covers 10-11 meters
- Stainless steel whip
- Overall length 50"
- 3/8" x 24 thread
- Adjustable stainless whip can be raised or lowered for better SWR
- Available in White (W) or Black (B)



| MODEL NO. | CASE QTY. |
|-----------|-----------|
| TRX-1011 | 6 |

PROWLER SERIES

Individual Whip Antennas

- Top loaded 1/4 wave 11 meter whip antennas
- Wound with Solarcons unique **EWSM (exact wire to wavelength match) manufacturing**
- 5/16" fiberglass wound with either 20Ga or 16Ga (classic series) copper wire
- Anti-static UV resistant PVC jacket

| Prowler | | | |
|----------------|--------|-----------|-----------|
| MODEL NO. | LENGTH | WATTAGE | CASE QTY. |
| 202 | 24" | 750 Watts | 6 |
| 203 | 36" | 750 Watts | 6 |
| 204 | 48" | 750 Watts | 6 |

Also Available in Bulk, 25 per Carton

| Prowler Classic | | | |
|------------------------|--------|------------|-----------|
| MODEL NO. | LENGTH | WATTAGE | CASE QTY. |
| 203CL | 36" | 1000 Watts | 6 |
| 204CL | 48" | 1000 Watts | 6 |

Also Available in Bulk, 25 per Carton

Available in Red (R), White (W), Black (B), White/Gold (WG) and Black/Gold (BG).

Single And Double CB Antenna Mirror Mount Kits

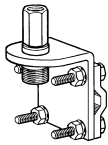

- Complete kits with genuine Prowler antennas
- Soldered PL259 connector with low loss cable
- Chrome plated brass ferrules

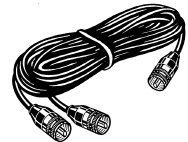
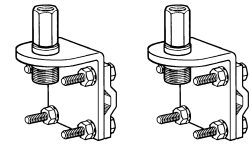

| Single Kits | | | | |
|--------------------|---------------|--------|--------------------|-----------|
| MODEL NO. | ANTENNA STYLE | LENGTH | CABLE | CASE QTY. |
| 212 | 202 | 24" | 9'RG58/AU PL-PL | 6 |
| 213 | 203 | 36" | 9'RG58/AU PL-PL | 6 |
| 214 | 204 | 48" | 9'RG58/AU PL-PL | 6 |
| 213CL | 203CL | 36" | 9'RG58/AU PL-PL | 6 |
| 214CL | 204CL | 48" | 9'RG58/AU PL-PL | 6 |

| Double Kits | | | | |
|--------------------|---------------|--------|------------------------|-----------|
| MODEL NO. | ANTENNA STYLE | LENGTH | CABLE | CASE QTY. |
| 222 | 202 | 24" | 9' RG59/AU Co-Phase | 6 |
| 223 | 203 | 36" | 9' RG59/AU Co-Phase | 6 |
| 224 | 204 | 48" | 9' RG59/AU Co-Phase | 6 |
| 223CL | 203CL | 36" | 9' RG59/AU Co-Phase | 6 |
| 224CL | 204CL | 48" | 9' RG59/AU Co-Phase | 6 |

Frantastic Super Strong Fiberglass CB Antennas

- Parallel Helical Design, Dielectrically and Inductively Compressed
- Double Quarter Wave, Factory Pre-Tuned
- Chrome Plated 3/8" x 24 Ferrule
- Fully Fiberglass Encapsulated, **Larger and Stronger Than the Competition**
- Available individually or in single and double kits

| MODEL | COLOR | LENGTH | CASE QTY |
|---------|-------|--------|----------|
| SCB20 | W/B | 2' | 6 |
| SCB22B | W/B | 3' | 6 |
| SCB24B | W/B | 4' | 6 |
| SCB20SK | W/B | 2' | 6 |
| SCB22SK | W/B | 3' | 6 |
| SCB24SK | W/B | 4' | 6 |
| SCB20DK | W/B | 2' | 6 |
| SCB22DK | W/B | 3' | 6 |
| SCB24DK | W/B | 4' | 6 |

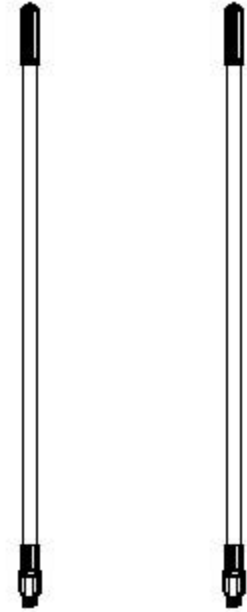

A-3000 And 1.2K Helical Antenna Series

- Helicly loaded 1/4 wave
- Wide Banded 25-30 mHz
- A-3000 is 24K gold plated
- 1.2K is triple plated chrome
- Tunable whip
- Open air helix coil for broad band width and high power handling
- Plated stainless steel whip

A-3000 And 1.2K

| | | | |
|---------------|----------|--------|---|
| A-3000 | 24K Gold | 59.00" | 6 |
| A-3001 | 24K Gold | 63.50" | 6 |
| | | | |
| 1.2K | Chrome | 59.00" | 6 |
| 1.4K | Chrome | 63.50" | 6 |

| Accessory Extensions | | |
|-----------------------------|----------|-----------|
| MODEL NO. | STYLE | CASE QTY. |
| EX 3G | 24K Gold | 6 |
| EX 8G | 24K Gold | 6 |
| | | |
| EX 3C | Chrome | 6 |
| EX 8C | Chrome | 6 |



Ground Zero

Revolutionary Design Works Where Other Antennas Fail

- 1/2 wave voltage fed antenna, *no ground required*
- Will work on fiberglass vehicles, boats, RV's and even motorcycles
- 10-11 meter range, overall length 48"
- *1/2 wave design increases range* by raising current maximum higher than 1/4 wave designs
- VCC tuning for low SWR and sideband use
- Patented TM circuit for precise impedance matching and decoupling of antenna currents

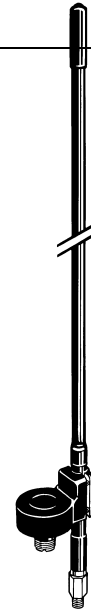

| MODEL NO. | CASE QTY. |
|-----------|-----------|
| GZero48 | 10 |

Triple Load



- Triple loaded 1/4 wave
- Broad Banded 10-11 meters
- 18-gauge red wire - three coils
- Tunable tip for best SWR
- Hi Power 1500 watts P.E.P.
- Clear anti-static jacket
- 3/8" x 24 thread
- Overall length 50"
- Available Black/Red (BR) or White/Red (WR)
- Single & Double kits available

| MODEL NO. | CASE QTY. |
|-----------|-----------|
| 3LT-48 | 6 |

A50 1/2 Wave 6 Meter Fiberglass Omni Directional Base

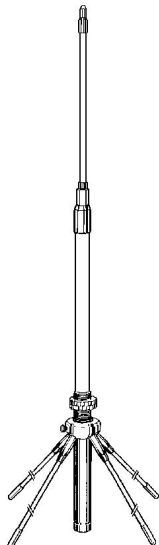





- Half Wave Design
- 51-54 MHz Frequency.
- Field Tunable 48 to 54 MHz
- 500 Watt
- 2.5 dbi Gain
- Quick, Easy Assembly
- Each Antenna Individually Tested
- Designed and Manufactured in the U.S.A.

*The A-50 features the Solarcon **Twin Ring Adjust-A-Match** tuning making it possible to tune the input to the antenna and obtain the optimum S.W.R. over a range of frequencies. Raising the rings raises the frequency and lowering the rings lowers the fre-*

U.S. Patent #4,360,814. Canadian Patent #1,145,456. England Patent #2,046,529.
Other patents pending

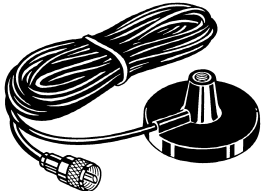
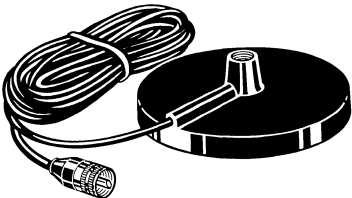
| MODEL # | CASE QTY. |
|---------|-----------|
| A-50 | 9 |

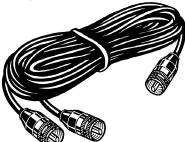
MOUNTS CABLE

| PRODUCT | CATALOG # | DESCRIPTION | CASE QTY. |
|---|--------------------------|---|-----------|
|  | MAG-3 MAG-318 | <ul style="list-style-type: none"> • 3" encapsulated plastic magnet mount with 12' or 18' of RG58/AU cable and soldered PL-259 connector • Completely waterproof design • 3/8" x 24 standard mount • 6 pole magnet | 12 |
|  | MAG-5 MAG-518 | <ul style="list-style-type: none"> • 5" encapsulated plastic magnet mount with 12' or 18' of RG58/AU cable and soldered PL-259 connector • Completely waterproof design • Rated for heavier antennas • 3/8" x 24 standard mount • 6 pole magnet | 8 |
|  | CPL-9 | <ul style="list-style-type: none"> • RG58/AU cable with two PL-259 connectors • Connectors soldered • Comes in 9' Length, bulk | 12 |
|  | CDPL-9 | <ul style="list-style-type: none"> • Co-phase of RG59/AU cable with PL-259 connectors • Connectors soldered • Comes in 9' Length, bulk | 12 |
|  | HWM-1 | <p>Now in stock from Solarcon the Famous HWM-1 Mount. This indestructible mount manufactured for years by Mobile Mark is now available from Solarcon. Solarcon purchased all equipment and materials from Mobile Mark to be able to continue to bring the fantastic mount to market. We haven't change a thing on this classic mount, same brutally tough gray fiberglass molded case. Same high quality plated components including the same heavy duty star washer.</p> | 36 |